

PRICE LIST - AUGUST 2024



KITCHEN WARDROBE & HARDWARE



www.gogaworld.com



**MODULAR KITCHEN
STORAGE SOLUTION
& HARDWARE FITTINGS**

INDEX

01

Auto hinges

04

Slim Tandem Box

05

Telescopic Channel

07

Pantry Unit

08

Pull Out

10

Swing Corner

11

Magic Corner

12

Pull Down System &
Wicker Basket

13

Roller Shutters

14

Kitchen Organiser

16

Door Lifter

17

Wire Kitchen Basket
& Accessories

23

Aluminium Profile

25

End Cap, Connector
& Table Bracket

27

Wardrobe Sliding Fitting

29

Push Magnet & Bed Fitting

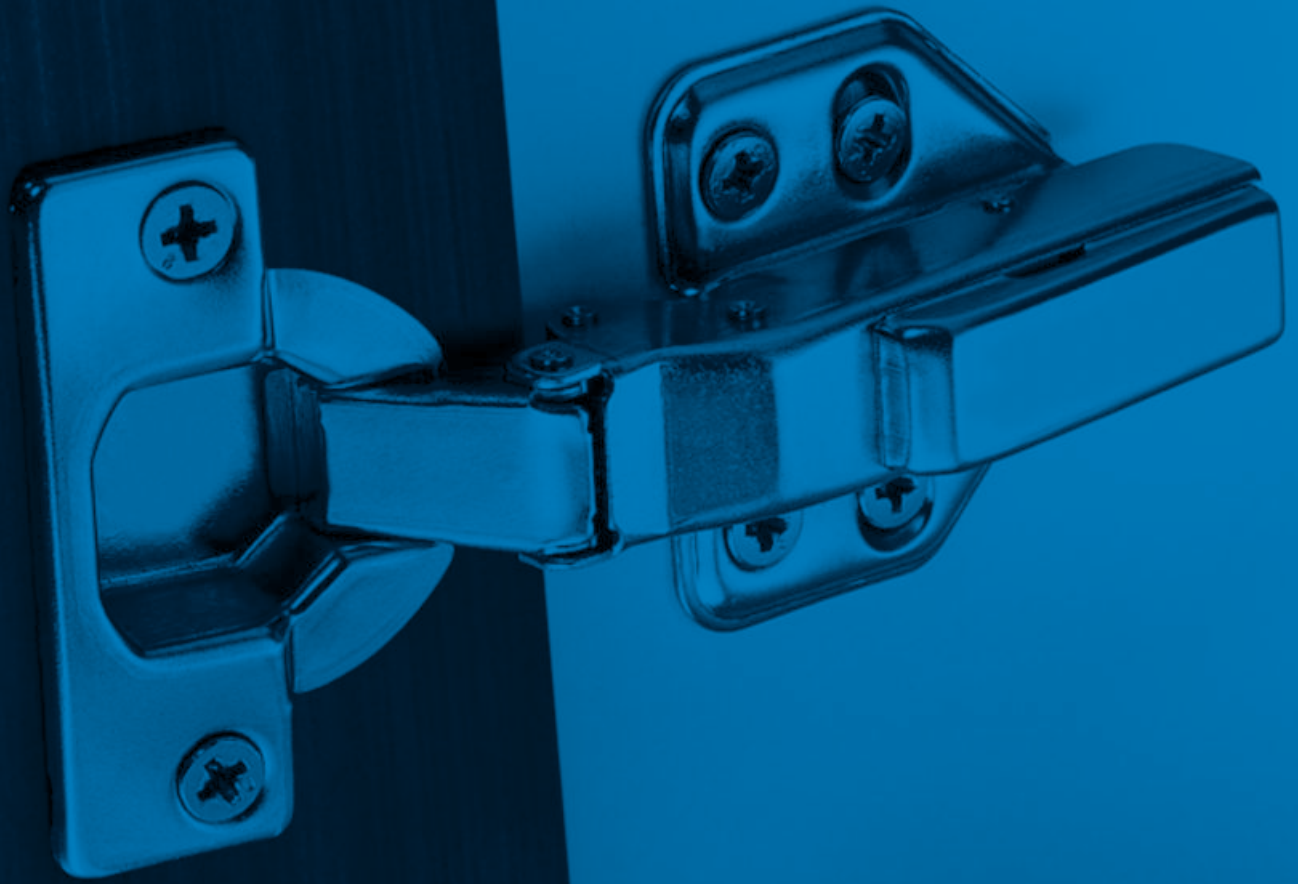

PREMIUM
HYDRAULIC
HINGES



SOFT CLOSE CLIP-ON 3D HINGE OPENING ANGLE 110°

Item Code	Size (mm)	Finish	Unit	Pack. Unit	MRP
G-AH-1114-3D-00	0 Crank	Gun Black	Set	50	375.00
G-AH-1114-3D-08	8 Crank	Gun Black	Set	50	385.00
G-AH-1114-3D-15	15 Crank	Gun Black	Set	50	395.00



SOFT CLOSE CLIP-ON 3D HINGE OPENING ANGLE 110°

Item Code	Size (mm)	Finish	Unit	Pack. Unit	MRP
G-AH-1109-3D-00	0 Crank	Nickle Plated	Set	50	315.00
G-AH-1109-3D-08	8 Crank	Nickle Plated	Set	50	325.00
G-AH-1109-3D-15	15 Crank	Nickle Plated	Set	50	335.00



SS SOFT CLOSE CLIP-ON 2D HINGES OPENING ANGLE 105°

Item Code	Size (mm)	Finish	Unit	Pack. Unit	MRP
G-AH-1110-2D-00	0 Crank	SS	Set	50	295.00
G-AH-1110-2D-08	8 Crank	SS	Set	50	305.00
G-AH-1110-2D-15	15 Crank	SS	Set	50	315.00



SOFT CLOSE CLIP-ON 2D HINGE OPENING ANGLE 110°

Item Code	Size (mm)	Finish	Unit	Pack. Unit	MRP
G-AH-1115-2D-00	0 Crank	Nickle Plated	Set	50	265.00
G-AH-1115-2D-08	8 Crank	Nickle Plated	Set	50	275.00
G-AH-1115-2D-15	15 Crank	Nickle Plated	Set	50	285.00



SOFT CLOSE SLIP-ON 2D HINGE OPENING ANGLE 110°

Item Code	Size (mm)	Finish	Unit	Pack. Unit	MRP
G-AH-1116-00	0 Crank	Nickle Plated	Set	100	215.00
G-AH-1116-08	8 Crank	Nickle Plated	Set	100	225.00
G-AH-1116-15	15 Crank	Nickle Plated	Set	100	235.00



SELF CLOSE SLIP-ON HINGE OPENING ANGLE 110°

Item Code	Size (mm)	Finish	Unit	Pack. Unit	MRP
G-AH-1117-00	0 Crank	Nickle Plated	Set	100	93.00
G-AH-1117-08	8 Crank	Nickle Plated	Set	100	96.00
G-AH-1117-15	15 Crank	Nickle Plated	Set	100	99.00



PROFILE 3D HINGES CLIP-ON OPENING ANGLE 105°

Item Code	Size (mm)	Finish	Unit	Pack. Unit	MRP
G-AH-1118-3D-00	0 Crank	Gun Black	Set	50	480.00



BLIND CORNER HINGE OPENING ANGLE 135°

Item Code	Size (mm)	Finish	Unit	Pack. Unit	MRP
G-AH-1112-135	135°	Nickle Plated	Set	50	310.00



WIDE ANGLE SOFT CLOSE 3D HINGE OPENING ANGLE 165°

Item Code	Size (mm)	Finish	Unit	Pack. Unit	MRP
G-AH-1111-3D-00	0 Crank	Nickle Plated	Set	50	880.00

PREMIUM
SLIM TANDEM
BOX



SLIM TANDEM BOX

Height : 84mm
Load Bearing Capacity : 40 Kg.

Item Code	Size (mm)	Finish	Unit	Pack. Unit	MRP
G-STB-1102-84-300	300	Grey	Set	4	3450.00
G-STB-1102-84-350	350	Grey	Set	4	3500.00
G-STB-1102-84-400	400	Grey	Set	4	3550.00
G-STB-1102-84-450	450	Grey	Set	4	3600.00
G-STB-1102-84-500	500	Grey	Set	4	3650.00
G-STB-1102-84-550	550	Grey	Set	4	3850.00



SLIM TANDEM BOX

Height : 116mm
Load Bearing Capacity : 40 Kg.

Item Code	Size (mm)	Finish	Unit	Pack. Unit	MRP
G-STB-1103-116-300	300	Grey	Set	4	3950.00
G-STB-1103-116-350	350	Grey	Set	4	4000.00
G-STB-1103-116-400	400	Grey	Set	4	4050.00
G-STB-1103-116-450	450	Grey	Set	4	4100.00
G-STB-1103-116-500	500	Grey	Set	4	4150.00
G-STB-1103-116-550	550	Grey	Set	4	4350.00



SLIM TANDEM BOX

Height : 167mm
Load Bearing Capacity : 40 Kg.

Item Code	Size (mm)	Finish	Unit	Pack. Unit	MRP
G-STB-1104-167-300	300	Grey	Set	4	4250.00
G-STB-1104-167-350	350	Grey	Set	4	4300.00
G-STB-1104-167-400	400	Grey	Set	4	4350.00
G-STB-1104-167-450	450	Grey	Set	4	4400.00
G-STB-1104-167-500	500	Grey	Set	4	4450.00
G-STB-1104-167-550	550	Grey	Set	4	4650.00

A close-up, low-angle photograph of two telescopic channel hardware components. The components are dark-colored, possibly black or dark grey, and are shown in a perspective view that emphasizes their length and the precision of their manufacturing. The top component is slightly offset from the bottom one, showing the interlocking mechanism of the channels. The background is a solid, vibrant blue, which makes the dark hardware stand out. The lighting is dramatic, highlighting the metallic texture and the various holes and slots along the length of the channels.

PREMIUM
TELESCOPIC
CHANNEL

FULL EXTENSION TELESCOPIC DRAWER SLIDES

Load Bearing Capacity : 45 Kg.



Item Code	Size (mm)	Finish	Unit	Pack. Unit	MRP
G-TC-1101-10-ZN	250	Zinc	Set	15	380.00
G-TC-1101-12-ZN	300	Zinc	Set	15	432.00
G-TC-1101-14-ZN	350	Zinc	Set	15	504.00
G-TC-1101-16-ZN	400	Zinc	Set	15	576.00
G-TC-1101-18-ZN	450	Zinc	Set	15	648.00
G-TC-1101-20-ZN	500	Zinc	Set	15	720.00
G-TC-1101-22-ZN	550	Zinc	Set	15	792.00
G-TC-1101-24-ZN	600	Zinc	Set	15	864.00
G-TC-1101-10-BL	250	Black	Set	15	360.00
G-TC-1101-12-BL	300	Black	Set	15	432.00
G-TC-1101-14-BL	350	Black	Set	15	504.00
G-TC-1101-16-BL	400	Black	Set	15	576.00
G-TC-1101-18-BL	450	Black	Set	15	648.00
G-TC-1101-20-BL	500	Black	Set	15	720.00
G-TC-1101-22-BL	550	Black	Set	15	792.00
G-TC-1101-24-BL	600	Black	Set	15	864.00

FULL EXTENSION TELESCOPIC DRAWER SLIDES

Load Bearing Capacity : 35 Kg.



Item Code	Size (mm)	Finish	Unit	Pack. Unit	MRP
G-TC-1134-8-ZN	200	Zinc	Set	15	290.00
G-TC-1134-10-ZN	250	Zinc	Set	15	295.00
G-TC-1134-12-ZN	300	Zinc	Set	15	354.00
G-TC-1134-14-ZN	350	Zinc	Set	15	413.00
G-TC-1134-16-ZN	400	Zinc	Set	15	472.00
G-TC-1134-18-ZN	450	Zinc	Set	15	531.00
G-TC-1134-20-ZN	500	Zinc	Set	15	590.00
G-TC-1134-22-ZN	550	Zinc	Set	15	649.00
G-TC-1134-24-ZN	600	Zinc	Set	15	708.00

**SOFT CLOSE FULL EXTENSION
TELESCOPIC DRAWER SLIDES**

Load Bearing Capacity : 35 Kg.



Item Code	Size (mm)	Finish	Unit	Pack. Unit	MRP
G-TC-SC-1119-12-ZN	300	Zinc	Set	15	750.00
G-TC-SC-1119-14-ZN	350	Zinc	Set	15	870.00
G-TC-SC-1119-16-ZN	400	Zinc	Set	15	995.00
G-TC-SC-1119-18-ZN	450	Zinc	Set	15	1120.00
G-TC-SC-1119-20-ZN	500	Zinc	Set	15	1240.00

**STAINLESS STEEL FULL EXTENSION
TELESCOPIC DRAWER SLIDES**

Load Bearing Capacity : 35 Kg.



Item Code	Size (mm)	Finish	Unit	Pack. Unit	MRP
G-TC-1120-250-SS	250	SS	Set	15	580.00
G-TC-1120-300-SS	300	SS	Set	15	690.00
G-TC-1120-350-SS	350	SS	Set	15	800.00
G-TC-1120-400-SS	400	SS	Set	15	910.00
G-TC-1120-450-SS	450	SS	Set	15	1020.00
G-TC-1120-500-SS	500	SS	Set	15	1140.00



**PREMIUM
VERTICAL
STORAGE**



GLASS PANTRY UNIT WITH 12 SOLID BASE BASKET

Cabinet Width : 450mm & 600mm

Item Code	Size (mm) W x D X H	Finish	Unit	Pack. Unit	MRP
G-GRPU-450	400x495x1830mm (Cabinet Width 450mm)	Grey	Set	1	29925.00
G-GRPU-600	550x495x1830mm (Cabinet Width 600mm)	Grey	Set	1	34425.00



FLAT LINE PANTRY UNIT WITH 12 SOLID BASE BASKET

Cabinet Width : 450mm & 600mm

Item Code	Size (mm) W x D X H	Finish	Unit	Pack. Unit	MRP
G-FLPU-450	400x495x1830mm (Cabinet Width 450mm)	Grey	Set	1	27135.00
G-FLPU-600	550x495x1830mm (Cabinet Width 600mm)	Grey	Set	1	31185.00

GLASS PULL OUT SIDE MOUNTED WITH SOLID BASE BASKET

Glass Basket - Universal

Item Code	Size (mm)	Finish	Unit	Pack. Unit	MRP
G-GRPO-02-200	2 Layer (Cabinet Width 200mm)	Grey	Set	1	7650.00
G-GRPO-02-250	2 Layer (Cabinet Width 250mm)	Grey	Set	1	8100.00
G-GRPO-02-300	2 Layer (Cabinet Width 300mm)	Grey	Set	1	8550.00

GLASS PULL OUT SIDE MOUNTED WITH SOLID BASE BASKET

Glass Basket - Universal

Item Code	Size (mm)	Finish	Unit	Pack. Unit	MRP
G-GRPO-03-200	3 Layer (Cabinet Width 200mm)	Grey	Set	1	9225.00
G-GRPO-03-250	3 Layer (Cabinet Width 250mm)	Grey	Set	1	9900.00
G-GRPO-03-300	3 Layer (Cabinet Width 300mm)	Grey	Set	1	10575.00

FLAT LINE PULL OUT SIDE MOUNTED WITH SOLID BASE BASKET

Glass Basket - Universal

Item Code	Size (mm)	Finish	Unit	Pack. Unit	MRP
G-FLPO-02-200	2 Layer (Cabinet Width 200mm)	Grey	1	1	7050.00
G-FLPO-02-250	2 Layer (Cabinet Width 250mm)	Grey	Set	1	7500.00
G-FLPO-02-300	2 Layer (Cabinet Width 300mm)	Grey	Set	1	7900.00

FLAT LINE PULL OUT SIDE MOUNTED WITH SOLID BASE BASKET

Glass Basket - Universal

Item Code	Size (mm)	Finish	Unit	Pack. Unit	MRP
G-FLPO-03-200	3 Layer (Cabinet Width 200mm)	Grey	Set	1	8500.00
G-FLPO-03-250	3 Layer (Cabinet Width 250mm)	Grey	Set	1	8100.00
G-FLPO-03-300	3 Layer (Cabinet Width 300mm)	Grey	Set	1	9720.00



FLAT LINE SWING CORNER SOLID BASE BASKET

Left Side Basket - 900mm

Item Code	Size (mm)	Finish	Unit	Pack. Unit	MRP
G-FLSC-LEFT	788x600 750x466 (Cabinet Width 900mm)	Grey	Set	1	13860.00



FLAT LINE SWING CORNER SOLID BASE BASKET

Right Side Basket - 900mm

Item Code	Size (mm)	Finish	Unit	Pack. Unit	MRP
G-FLSC-RIGHT	788x600 750x466 (Cabinet Width 900mm)	Grey	Set	1	13860.00



GLASS MAGIC CORNER UNIVERSAL

Glass Mounted Wall Solid Base Basket

Item Code	Size (mm) WxDxH	Finish	Unit	Pack. Unit	MRP
G-UGMC-900	680x510x605mm (Cabinet Width 900mm)	Grey	Set	1	23850.00



FLAT LINE MAGIC CORNER UNIVERSAL

Grey Mounted Wall Solid Base Basket

Item Code	Size (mm)	Finish	Unit	Pack. Unit	MRP
G-FLMC-900	680x510x605mm (Cabinet Width 900mm)	Grey	Set	1	22275.00



PULL DOWN SYSTEM

Glass Mounted 600mm & 900mm

Item Code	Size (mm) WxDxH	Finish	Unit	Pack. Unit	MRP
G-PS-1121-600	600x300x500	Grey	Set	1	22000.00
G-PS-1121-900	900x300x500	Grey	Set	1	25000.00



WOODEN WICKER BASKET

Cabinet Width : 450mm & 600mm

Item Code	Size (mm) WxDxH	Finish	Unit	Pack. Unit	MRP
G-WB-1114-100-450	414x508x100	Light Brown	Set	1	6250.00
G-WB-1114-100-600	564x508x100	Light Brown	Set	1	7250.00
G-WB-1115-150-450	414x508x150	Light Brown	Set	1	6350.00
G-WB-1115-150-600	564x508x150	Light Brown	Set	1	7350.00
G-WB-1116-200-450	414x508x200	Light Brown	Set	1	6450.00
G-WB-1116-200-600	564x508x200	Light Brown	Set	1	7450.00



PVC ROLLER SHUTTER

Cabinet Size : 600mm

Item Code	Size (mm) WxH	Finish	Unit	Pack. Unit	MRP
G-RS-1122-600	600x1320	Silver	1 Set	1+1(2 Box)	16500.00
		Black	1 Set	1+1(2 Box)	18500.00

PREMIUM ALUMINIUM SILVER ROLLER SHUTTER

Cabinet Size : 600mm

Item Code	Size (mm) WxH	Finish	Unit	Pack. Unit	MRP
G-RS-1123-600	600x1320	Silver	1 Set	1+1(2 Box)	36500.00



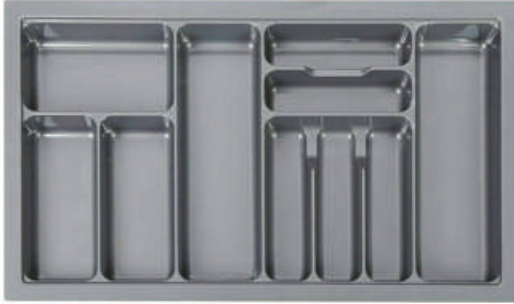

PVC CUTLERY TRAY

Item Code	Size (mm) WxDxH (Cabinet Width)	Finish	Unit	Pack. Unit	MRP
G-PCT-1105-450	380x483x50 (450mm)	Grey	Pcs.	10	950.00
G-PCT-1105-500	430x483x50 (500mm)	Grey	Pcs.	10	1050.00
G-PCT-1105-600	530x483x50 (600mm)	Grey	Pcs.	10	1150.00
G-PCT-1105-700	630x483x50 (700mm)	Grey	Pcs.	10	1450.00
G-PCT-1105-800	730x483x50 (800mm)	Grey	Pcs.	10	1600.00
G-PCT-1105-900	830x483x50 (900mm)	Grey	Pcs.	10	1750.00

CUP & SAUCER PARTITION

For Slim Tandem Box

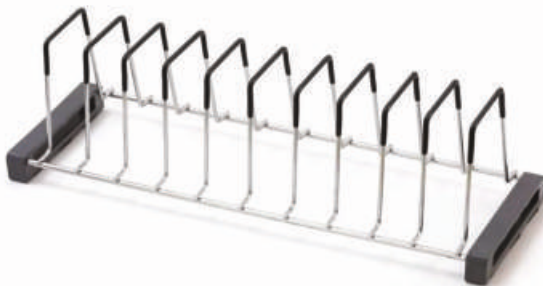
Item Code	Size (mm)	Finish	Unit	Pack. Unit	MRP
G-TS-1106-500	485x100	SS	Pcs.	5	910.00

PLATE PARTITION

For Slim Tandem Box

Item Code	Size (mm)	Finish	Unit	Pack. Unit	MRP
G-TS-1107-500	485x150	SS	Pcs.	5	960.00

THALI PARTITION

For Slim Tandem Box

Item Code	Size (mm)	Finish	Unit	Pack. Unit	MRP
G-TS-1108-500	485x200	SS	Pcs.	5	990.00



SS DISH RACK AND HOLDER

Item Code	Size (mm) WxDxH	Finish	Unit	Pack. Unit	MRP
G-DH-1123-600	600x300x500	SS	Set	5	2300.00
G-DH-1123-900	900x300x500	SS	Set	5	3400.00



SS DUSTBIN HOLDER ROUND (8Ltr.)

Item Code	Size (mm)	Finish	Unit	Pack. Unit	MRP
G-BH-1128	300x300x280	SS	Set	1	3200.00



ANTI-SKID MAT

Item Code	Size (MMxMtr.)	Finish	Unit	Pack. Unit	MRP
G-ASM-1113-500	500x5Mtr.	Grey	Pcs.	4	1400.00
	500x20Mtr.	Grey	Pcs.	1	5400.00

DOOR LIFTER - 10"

Item Code	Load Capacity	Finish	Unit	Pack. Unit	MRP
G-DL-1126-05	5 Kg. (60N)	Gun Grey	Set	50	285.00
G-DL-1126-10	10 Kg. (100N)	Gun Grey	Set	50	295.00
G-DL-1126-15	15 Kg. (150N)	Gun Grey	Set	50	305.00
G-DL-1126-20	20 Kg. (200N)	Gun Grey	Set	50	315.00

DOOR LIFTER WITH SOFT CLOSE - 10"

Item Code	Load Capacity	Finish	Unit	Pack. Unit	MRP
G-DL-1127-05	5 Kg. (60N)	White	Set	50	450.00
G-DL-1127-10	10 Kg. (100N)	White	Set	50	470.00
G-DL-1127-15	15 Kg. (150N)	White	Set	50	495.00

BI-FOLD LIFT - UP

Item Code	Size (mm)	Finish	Unit	Pack. Unit	MRP
G-LFS-1124	(600-900)x300x500	Silver	Set	5	6750.00

UPWARD FREE STOP LIFT-UP

Item Code	Size (mm)	Finish	Unit	Pack. Unit	MRP
G-LFS-1125	(600-900)x300x300	Grey	Set	5	3850.00



PREMIUM
S.S. WIRE
BASKET



PLAIN BASKET - 4"

Item Code	Size (Inch) WxDxH	Finish	Unit	Pack. Unit	MRP
G-KB-706-15-20-4	15x20x4	SS	Pcs.	12	1800.00
G-KB-706-17-20-4	17x20x4	SS	Pcs.	12	1960.00
G-KB-706-19-20-4	19x20x4	SS	Pcs.	12	2150.00
G-KB-706-21-20-4	21x20x4	SS	Pcs.	12	2340.00
G-KB-706-24-20-4	24x20x4	SS	Pcs.	12	2820.00



PLAIN BASKET - 6"

Item Code	Size (Inch) WxDxH	Finish	Unit	Pack. Unit	MRP
G-KB-706-15-20-6	15x20x6	SS	Pcs.	8	2070.00
G-KB-706-17-20-6	17x20x6	SS	Pcs.	8	2250.00
G-KB-706-19-20-6	19x20x6	SS	Pcs.	8	2460.00
G-KB-706-21-20-6	21x20x6	SS	Pcs.	8	2670.00
G-KB-706-24-20-6	24x20x6	SS	Pcs.	8	3230.00



PLAIN BASKET - 8"

Item Code	Size (Inch) WxDxH	Finish	Unit	Pack. Unit	MRP
G-KB-706-15-20-8	15x20x8	SS	Pcs.	6	2480.00
G-KB-706-17-20-8	17x20x8	SS	Pcs.	6	2680.00
G-KB-706-19-20-8	19x20x8	SS	Pcs.	6	2930.00
G-KB-706-21-20-8	21x20x8	SS	Pcs.	6	3140.00
G-KB-706-24-20-8	24x20x8	SS	Pcs.	6	3780.00



CUP & SAUCER BASKET - 4"

Item Code	Size (Inch) WxDxH	Finish	Unit	Pack. Unit	MRP
G-KB-702-15-20-4	15x20x4	SS	Pcs.	12	2210.00
G-KB-702-17-20-4	17x20x4	SS	Pcs.	12	2480.00
G-KB-702-19-20-4	19x20x4	SS	Pcs.	12	2720.00
G-KB-702-21-20-4	21x20x4	SS	Pcs.	12	2950.00
G-KB-702-24-20-4	24x20x4	SS	Pcs.	12	3570.00



PERFORATED CUTLERY BASKET - 4"

Item Code	Size (Inch) WxDxH	Finish	Unit	Pack. Unit	MRP
G-KB-701-15-20-4	15x20x4	SS	Pcs.	12	3240.00
G-KB-701-17-20-4	17x20x4	SS	Pcs.	12	3470.00
G-KB-701-19-20-4	19x20x4	SS	Pcs.	12	3700.00
G-KB-701-21-20-4	21x20x4	SS	Pcs.	12	4070.00
G-KB-701-24-20-4	24x20x4	SS	Pcs.	12	4980.00



PLATE BASKET - 6"

Item Code	Size (Inch) WxDxH	Finish	Unit	Pack. Unit	MRP
G-KB-707-15-20-6	15x20x6	SS	Pcs.	8	2210.00
G-KB-707-17-20-6	17x20x6	SS	Pcs.	8	2390.00
G-KB-707-19-20-6	19x20x6	SS	Pcs.	8	2630.00
G-KB-707-21-20-6	21x20x6	SS	Pcs.	8	2850.00
G-KB-707-24-20-6	24x20x6	SS	Pcs.	8	3420.00



THALI BASKET - 8"

Item Code	Size (Inch) WxDxH	Finish	Unit	Pack. Unit	MRP
G-KB-708-15-20-8	15x20x8	SS	Pcs.	6	2600.00
G-KB-708-17-20-8	17x20x8	SS	Pcs.	6	2800.00
G-KB-708-19-20-8	19x20x8	SS	Pcs.	6	3040.00
G-KB-708-21-20-8	21x20x8	SS	Pcs.	6	3320.00
G-KB-708-24-20-8	24x20x8	SS	Pcs.	6	3980.00



VEGETABLE BASKET - 6"

Item Code	Size (Inch) WxDxH	Finish	Unit	Pack. Unit	MRP
G-KB-716-15-20-6	15x20x6	SS	Pcs.	8	5400.00
G-KB-716-17-20-6	17x20x6	SS	Pcs.	8	6210.00
G-KB-716-19-20-6	19x20x6	SS	Pcs.	8	6740.00
G-KB-716-21-20-6	21x20x6	SS	Pcs.	8	7450.00



WIRE BOTTLE PULL OUT 2 LAYER

Item Code	Size (Inch) WxDxH	Finish	Unit	Pack. Unit	MRP
G-KB-709-4-20-17	4x20x17	SS	Pcs.	12	2810.00
G-KB-709-6-20-17	6x20x17	SS	Pcs.	8	3130.00
G-KB-709-8-20-17	8x20x17	SS	Pcs.	6	3520.00
G-KB-709-10-20-17	10x20x17	SS	Pcs.	4	3850.00
G-KB-709-12-20-17	12x20x17	SS	Pcs.	4	4170.00

WIRE BOTTLE PULL OUT 3 LAYER

Item Code	Size (Inch) WxDxH	Finish	Unit	Pack. Unit	MRP
G-KB-709-4-20-21	4x20x21	SS	Pcs.	12	3600.00
G-KB-709-6-20-21	6x20x21	SS	Pcs.	8	4000.00
G-KB-709-8-20-21	8x20x21	SS	Pcs.	6	4550.00
G-KB-709-10-20-21	10x20x21	SS	Pcs.	4	4720.00
G-KB-709-12-20-21	12x20x21	SS	Pcs.	4	4890.00

CAROUSEL TRAY 3/4

Item Code	Size (Inch)	Finish	Unit	Pack. Unit	MRP
G-KB-710-20	20"	SS	Set	1	7650.00
G-KB-710-24	24"	SS	Set	1	8570.00

CAROUSEL TRAY FULL ROUND

Item Code	Size (Inch)	Finish	Unit	Pack. Unit	MRP
G-KB-717-20	20"	SS	Set	1	8610.00
G-KB-717-24	24"	SS	Set	1	9400.00

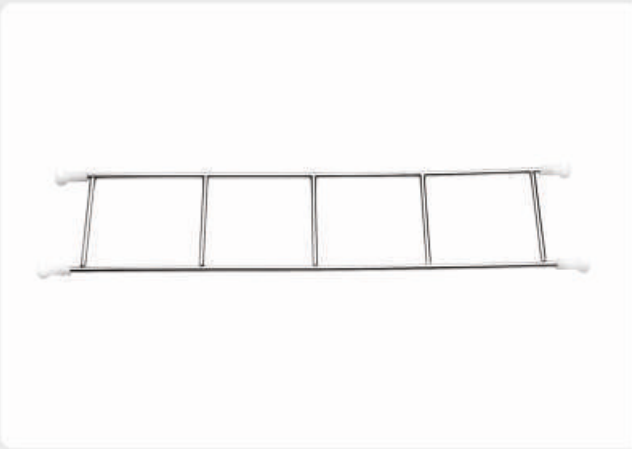
GLASS BASKET PARTITION - 4"

Item Code	Size (Inch) WxDxH	Finish	Unit	Pack. Unit	MRP
G-KB-703-20	20"	SS	Pcs.	10	360.00

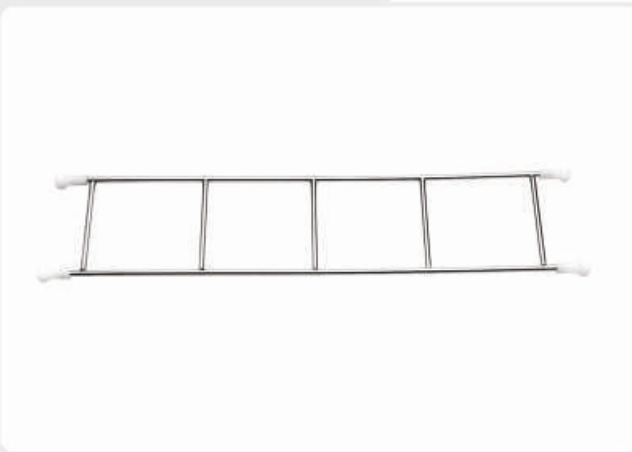
BOTTLE BASKET PARTITION - 6"

Item Code	Size (Inch) WxDxH	Finish	Unit	Pack. Unit	MRP
G-KB-704-20	20"	SS	Pcs.	10	395.00

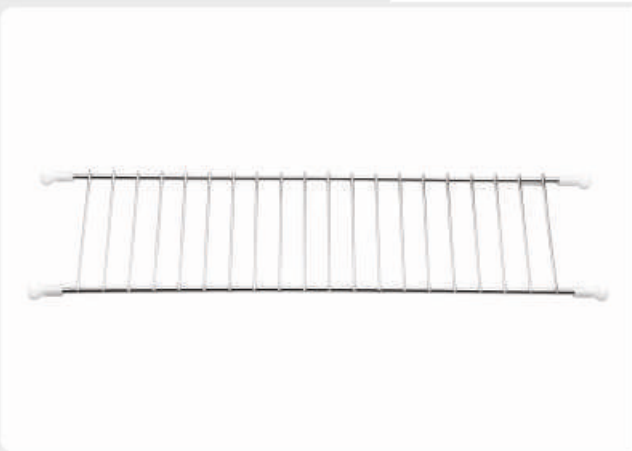
PLAIN BASKET PARTITION

Item Code	Size (Inch) DxH	Finish	Unit	Pack. Unit	MRP
G-KB-705-20-4	20x4	SS	Pcs.	10	360.00
G-KB-705-20-6	20x6	SS	Pcs.	10	415.00
G-KB-705-20-8	20x8	SS	Pcs.	10	495.00

PERFORATED DUSTBIN

Item Code	Size (Inch) DxH	Finish	Unit	Pack. Unit	MRP
G-KB-712-9-12	9x12	SS	Pcs.	1	1820.00
G-KB-712-10-14	10x14	SS	Pcs.	1	2140.00



PERFUME RACK

Item Code	Size (Inch) WxDxH	Finish	Unit	Pack. Unit	MRP
G-KB-715-12-4-4	12x4x4	SS	Pcs.	1	1230.00
G-KB-715-15-4-4	15x4x4	SS	Pcs.	1	1560.00



SHOE RACK

Item Code	Size (Inch) WxDxH	Finish	Unit	Pack. Unit	MRP
G-KB-711	20x13x20	SS	Pcs.	1	6180.00



CYLINDER TROLLEY

Item Code	Size	Finish	Unit	Pack. Unit	MRP
G-KB-713	Standard	SS	Pcs.	1	1440.00



DUSTBIN HOLDER

Item Code	Size	Finish	Unit	Pack. Unit	MRP
G-KB-714	Standard	SS	Pcs.	1	1120.00

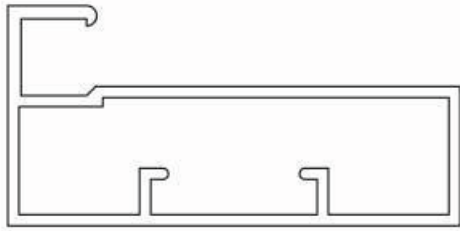

**PREMIUM
ALUMINIUM PROFILE
& SLIDING DOOR FITTING**

45MM STRAIGHT FRAME PROFILE

Size : 3 Mtr.

Item Code	Finish	Unit	Pack. Unit	MRP
G-AP-2002-RG	Rose Gold	Pcs.	10	2350.00
G-AP-2002-BG	Brush Gold	Pcs.	10	2250.00
G-AP-2002-CB	Ceramic Black	Pcs.	10	2210.00
G-AP-2002-IG	Iron Grey	Pcs.	10	2440.00

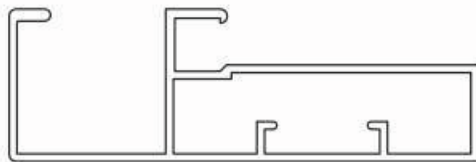
45MM STRAIGHT FRAME PROFILE WITH HANDLE

Size : 3 Mtr.

Item Code	Finish	Unit	Pack. Unit	MRP
G-AP-2003-RG	Rose Gold	Pcs.	10	3120.00
G-AP-2003-BG	Brush Gold	Pcs.	10	3050.00
G-AP-2003-CB	Ceramic Black	Pcs.	10	2950.00
G-AP-2003-IG	Iron Grey	Pcs.	10	3210.00

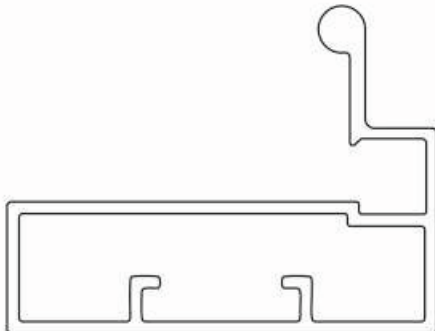
45MM STRAIGHT FRAME PROFILE WITH SLIM HANDLE

Size : 3 Mtr.

Item Code	Finish	Unit	Pack. Unit	MRP
G-AP-2004-RG	Rose Gold	Pcs.	10	2780.00
G-AP-2004-BG	Brush Gold	Pcs.	10	2730.00
G-AP-2004-CB	Ceramic Black	Pcs.	10	2590.00
G-AP-2004-IG	Iron Grey	Pcs.	10	2860.00

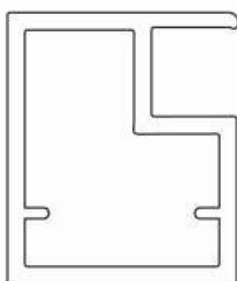
20 MM FRAME PROFILE

Size : 3 Mtr.

Item Code	Finish	Unit	Pack. Unit	MRP
G-AP-2023-RG	Rose Gold	Pcs.	20	1710.00
G-AP-2023-BG	Brush Gold	Pcs.	20	1580.00
G-AP-2023-CB	Ceramic Black	Pcs.	20	1580.00
G-AP-2023-IG	Iron Grey	Pcs.	20	1710.00

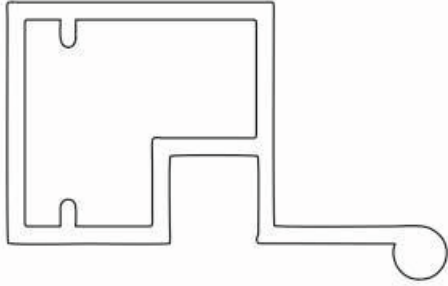
20 MM HANDLE PROFILE

Size : 3 Mtr.

Item Code	Finish	Unit	Pack. Unit	MRP
G-AP-2024-RG	Rose Gold	Pcs.	20	2290.00
G-AP-2024-CB	Brush Gold	Pcs.	20	2100.00
G-AP-2024-BG	Ceramic Black	Pcs.	20	2100.00
G-AP-2024-IG	Iron Grey	Pcs.	20	2290.00

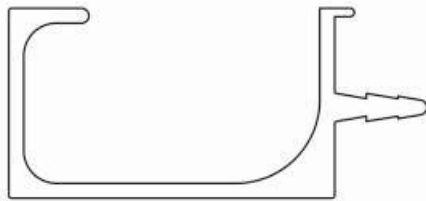
G - ALUMINIUM PROFILE

Size : 3 Mtr.

Item Code	Finish	Unit	Pack. Unit	MRP
G-AP-2001-RG	Rose Gold	Pcs.	10	2450.00
G-AP-2001-BG	Brush Gold	Pcs.	10	2510.00
G-AP-2001-CB	Ceramic Black	Pcs.	10	2195.00
G-AP-2001-IG	Iron Grey	Pcs.	10	2495.00

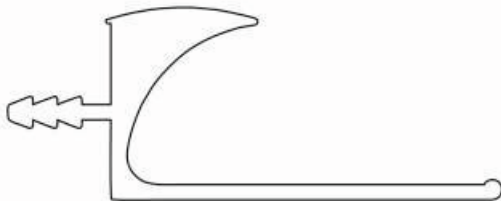
J - HANDLE PROFILE

Size : 3 Mtr.

Item Code	Finish	Unit	Pack. Unit	MRP
G-AP-2025-RG	Rose Gold	Pcs.	10	2600.00
G-AP-2025-CB	Ceramic Black	Pcs.	10	2600.00
G-AP-2025-BG	Brush Gold	Pcs.	10	2510.00
G-AP-2025-IG	Iron Grey	Pcs.	10	2600.00

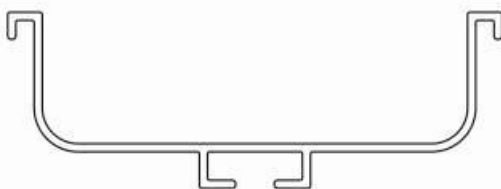
GOLA PROFILE C TYPE

Size : 3 Mtr.

Item Code	Finish	Unit	Pack. Unit	MRP
G-AP-2027-RG	Rose Gold	Pcs.	10	2380.00
G-AP-2027-CB	Ceramic Black	Pcs.	10	2540.00
G-AP-2027-BG	Brush Gold	Pcs.	10	2490.00
G-AP-2027-IG	Iron Grey	Pcs.	10	2380.00

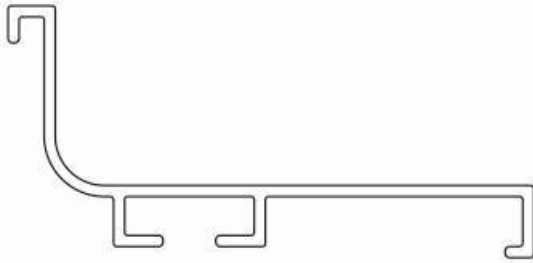
GOLA PROFILE J TYPE

Size : 3 Mtr.

Item Code	Finish	Unit	Pack. Unit	MRP
G-AP-2028-RG	Rose Gold	Pcs.	20	2040.00
G-AP-2028-CB	Ceramic Black	Pcs.	20	2040.00
G-AP-2028-BG	Brush Gold	Pcs.	20	1980.00
G-AP-2028-IG	Iron Grey	Pcs.	20	2040.00

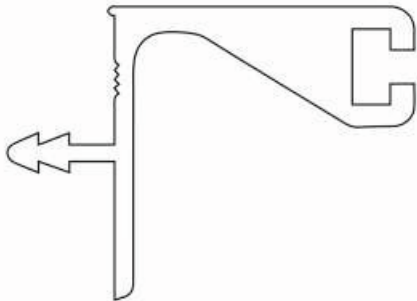
WALL GOLA PROFILE HANDLE 30 MM

Size : 3 Mtr.

Item Code	Finish	Unit	Pack. Unit	MRP
G-AP-2029-RG	Rose Gold	Pcs.	20	2050.00
G-AP-2029-CB	Ceramic Black	Pcs.	20	1800.00
G-AP-2029-BG	Brush Gold	Pcs.	20	1870.00
G-AP-2029-IG	Iron Grey	Pcs.	20	2050.00

END CAP FOR GOLA C TYPE USED WITH G-AP-2027

Item Code	Finish	Unit	Pack. Unit	MRP
G-EC-C-RG	Rose Gold	Set	50	95.00
G-EC-C-CB	Ceramic Black	Set	50	95.00
G-EC-C-BG	Brush Gold	Set	50	95.00
G-EC-C-IG	Iron Grey	Set	50	95.00

END CAP FOR GOLD J TYPE USED WITH G-AP-2028

Item Code	Finish	Unit	Pack. Unit	MRP
G-EC-L-RG	Rose Gold	Set	50	95.00
G-EC-L-CB	Ceramic Black	Set	50	95.00
G-EC-L-BG	Brush Gold	Set	50	95.00
G-EC-L-IG	Iron Grey	Set	50	95.00



END CAP FOR G TYPE USED WITH G-AP-2001

Item Code	Finish	Unit	Pack. Unit	MRP
G-EC-G-RG	Rose Gold	Pair	50	95.00
G-EC-G-CB	Ceramic Black	Pair	50	95.00
G-EC-G-BG	Brush Gold	Pair	50	95.00
G-EC-G-IG	Iron Grey	Pair	50	95.00



L - CONNECTOR

Item Code	Size (mm)	Finish	Unit	Pack. Unit	MRP
G-AP-2016	----	----	Set	100	130.00



GOLA CONNECTOR SET (4 Pcs.) USED WITH G-AP-2027

Item Code	Size (mm)	Finish	Unit	Pack. Unit	MRP
G-AP-2030	----	----	Set	100	95.00



TABLE BRACKET

Item Code	Size (mm)	Finish	Unit	Pack. Unit	MRP
G-CF-5078	300	Grey	Set	25	990.00
G-CF-5078	400	Grey	Set	20	1190.00
G-CF-5078	500	Grey	Set	15	1430.00
G-CF-5078	600	Grey	Set	15	1800.00

WARDROBE SLIDING FITTING TWO WAY SOFT CLOSE

Door Thickness : 18-25 mm
 Max Weight Per Door 60 Kg. Top Screw
 Two Door Kit Use With Track G-SF-1021, 1022

Item Code	Size (mm)	Finish	Unit	Pack. Unit	MRP
G-SF-1019	---	Zinc	Set	15	2250.00

WARDROBE SLIDING FITTING TWO WAY SOFT CLOSE

Door Thickness : 18-25 mm
 Max Weight Per Door 60 Kg. Back Screw
 Two Door Kit Use With Track G-SF-1021, 1022

Item Code	Size (mm)	Finish	Unit	Pack. Unit	MRP
G-SF-1035	---	Zinc	Set	15	2250.00

WARDROBE SLIDING FITTING TWO WAY SOFT CLOSE

Door Thickness : 18-25 mm
 Max Weight Per Door 60 Kg. Universal
 Two Door Kit Use With Track G-SF-1021, 1022

Item Code	Size (mm)	Finish	Unit	Pack. Unit	MRP
G-SF-1020	---	Zinc	Set	15	2850.00

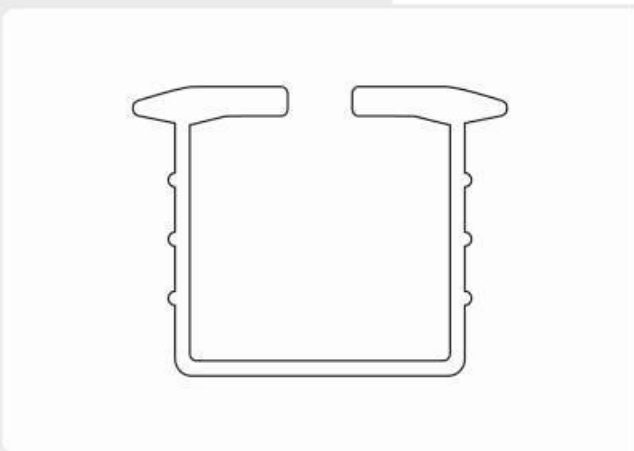
ALUMINIUM TRACK

Use With Track G-SF-1019, 1020 & 1035

Item Code	Size (mm)	Finish	Unit	Pack. Unit	MRP
G-SF-1022	2400	Silver	1 Set (2 Pcs.)	10	2250.00
G-SF-1022	3600	Silver	1 Set (2 Pcs.)	10	3450.00

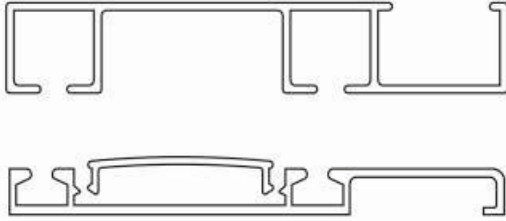
ALUMINIUM SLIM DOUBLE TRACK

Use With Track G-SF-1019, 1020 & 1035

Item Code	Size (mm)	Finish	Unit	Pack. Unit	MRP
G-SF-1021-SL	2400	Silver	Set	10	2450.00
G-SF-1021-SL	3600	Silver	Set	10	3850.00
G-SF-1021-CB	2400	Ceramic Black	Set	10	3200.00
G-SF-1021-CB	3600	Ceramic Black	Set	10	4800.00
G-SF-1021-RG	2400	Rose Gold	Set	10	3200.00
G-SF-1021-RG	3600	Rose Gold	Set	10	4800.00

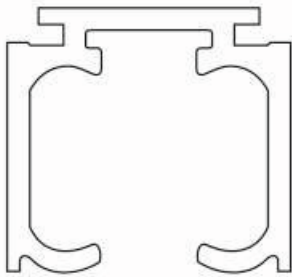
SLIDING TRACK FOR SINGLE DOOR

Use With Track G-SF-1026

Item Code	Size (mm)	Finish	Unit	Pack. Unit	MRP
G-SF-1025	2400.00	Silver	Pcs.	10	2950.00
G-SF-1025	3600.00	Silver	Pcs.	10	4350.00

WOODEN & ALUMINIUM SLIDING FITTING

 Two way Soft Close
 Weight Capacity : 45 to 80 Kg.
 Use With G-SF-1025

Item Code	Size (mm)	Finish	Unit	Pack. Unit	MRP
G-SF-1026	---	Zinc	Set	20	3250.00

PUSH OPEN FITTING MAGNETIC

Item Code	Size (mm)	Finish	Unit	Pack. Unit	MRP
G-PM-2031	100	Grey	Pcs.	1000	82.00

PUSH OPEN FITTING MAGNETIC

Item Code	Size (mm)	Finish	Unit	Pack. Unit	MRP
G-PM-2032	100	SS	Pcs.	1000	120.00

PUSH OPEN FITTING MAGNETIC

Item Code	Size (mm)	Finish	Unit	Pack. Unit	MRP
G-PM-2033	100	Silver	Pcs.	300	150.00

BED FITTING MECHANISM SET 5 MM THICKNESS

Item Code	Size (mm)	Finish	Unit	Pack. Unit	MRP
G-CF-5075	900	Black	Set	3	3250.00
G-CF-5075	1200	Black	Set	3	3550.00
G-CF-5075	1500	Black	Set	3	3850.00

GAS PUMP FOR BED FITTING

Item Code	Weight Capacity	Size (Inch)	Finish	Unit	Pack. Unit	MRP
G-CF-5078	75 Kg.	17"	Black	Set	10	1200.00
G-CF-5078	100 Kg.	17"	Black	Set	10	1200.00
G-CF-5078	125 Kg.	17"	Black	Set	10	1200.00
G-CF-5078	150 Kg.	17"	Black	Set	10	1200.00
G-CF-5078	175 Kg.	17"	Black	Set	10	1200.00
G-CF-5078	200 Kg.	17"	Black	Set	10	1200.00
G-CF-5078	250 Kg.	17"	Black	Set	10	1990.00



USE COTTON CLOTH TO CLEAN

DO NOT USE



THINNER



ACID



TOILET
CLEANER



MASKING
TAPE



DETERGENT
POWDER

NOTE : if you do not follow above instructions company will not be responsible for the product damage.



GOGA INTERIOR PRODUCTS PVT. LTD.

Plot No. 208, Arti Society Road, ST 10, Atika,
Dhebar Road, Bhaktinagar, Rajkot-360002 (Gujarat) INDIA.

Email : info@gogaworld.com | Web : www.gogaworld.com
TOLL FREE No. : 1800 570 1110

